

**SEABOARD BALLROOM**

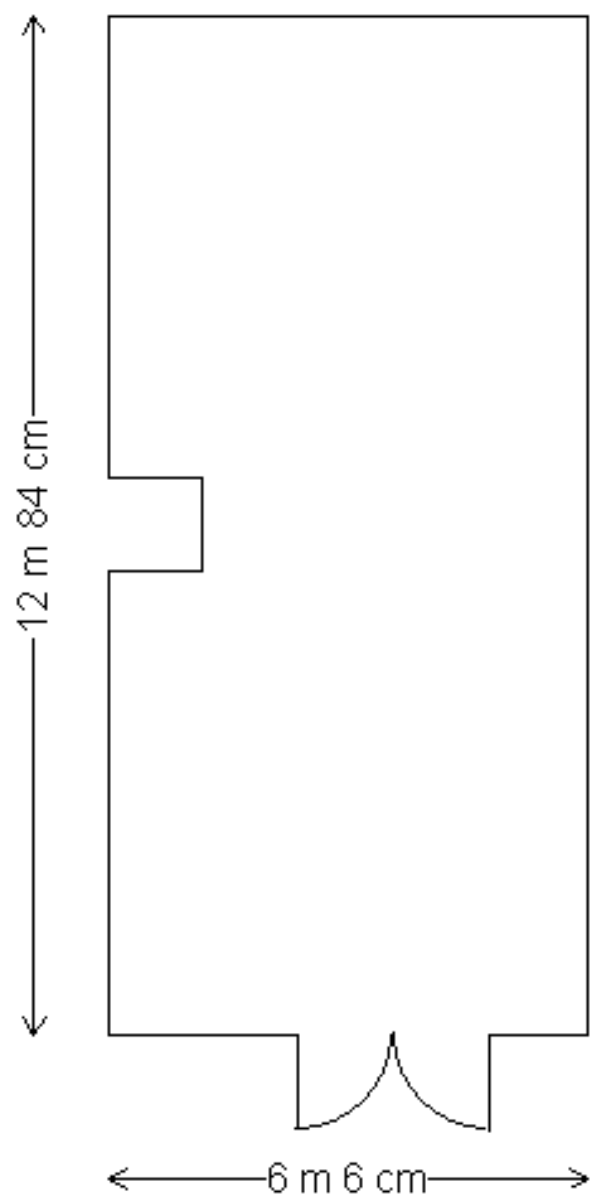

**SEABOARD BOARDROOM**

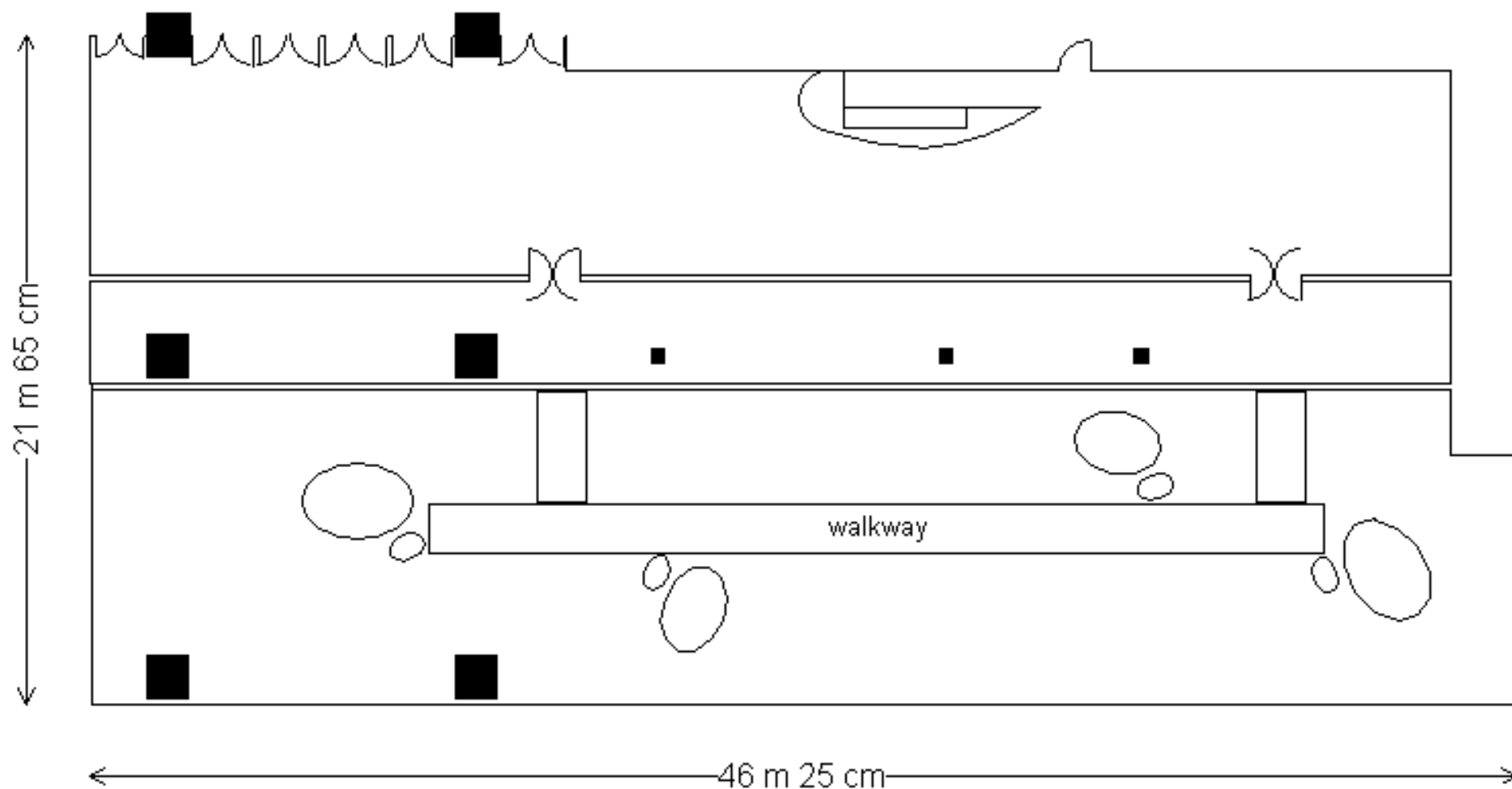

# DRIFT

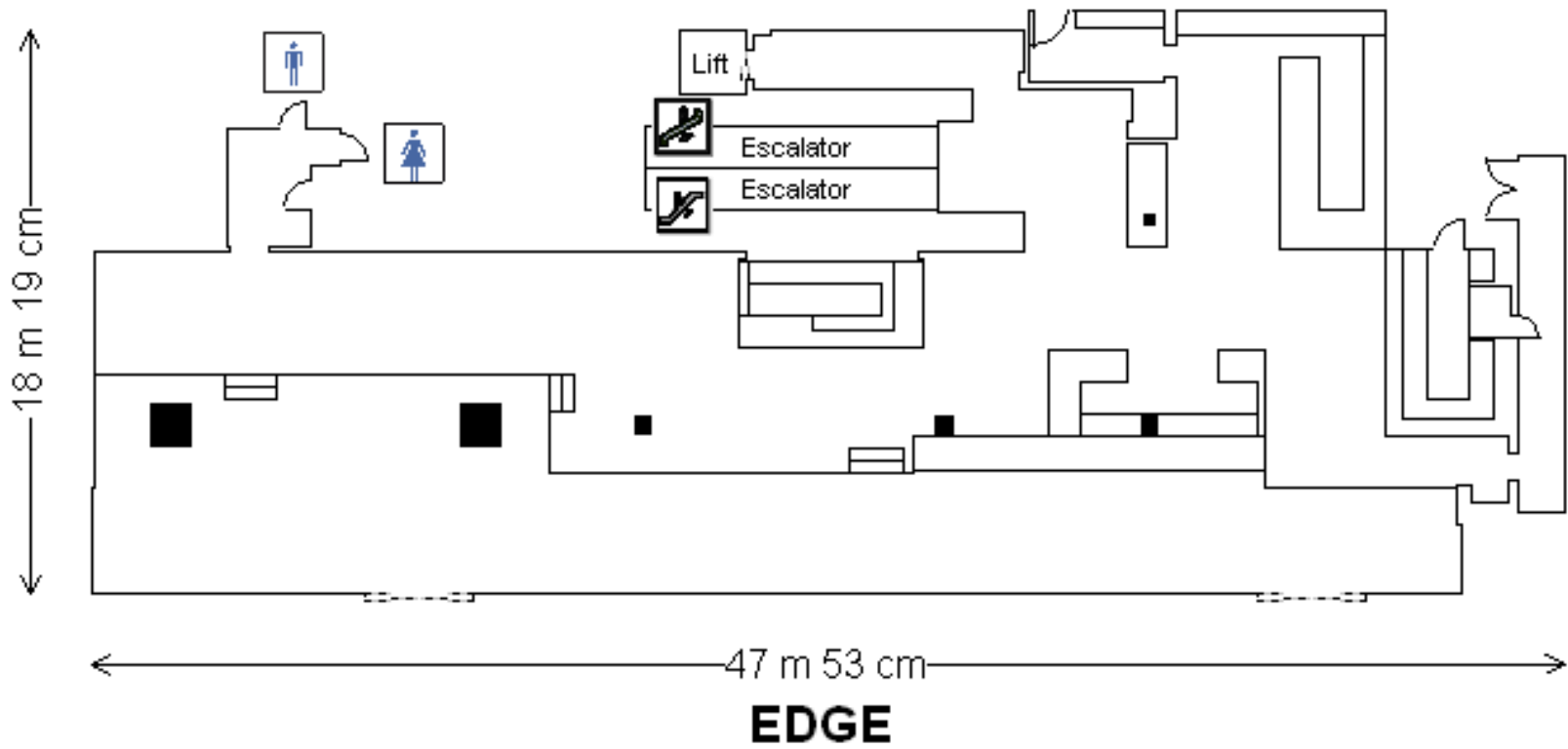

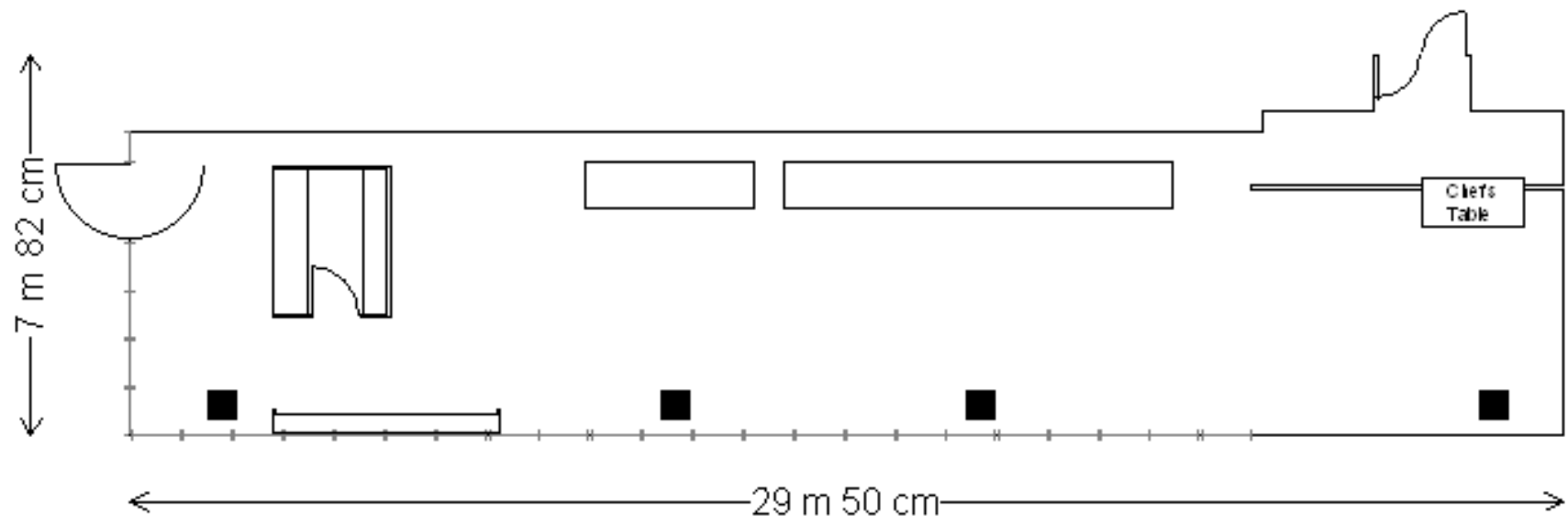

29 m 50 cm

**FLARE**

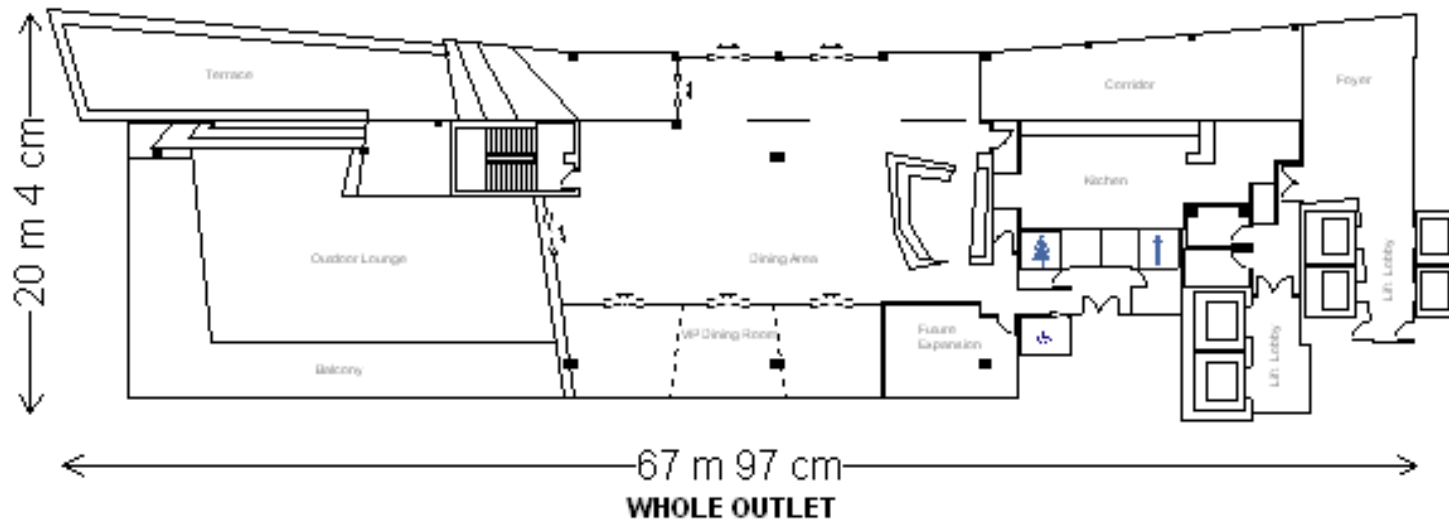

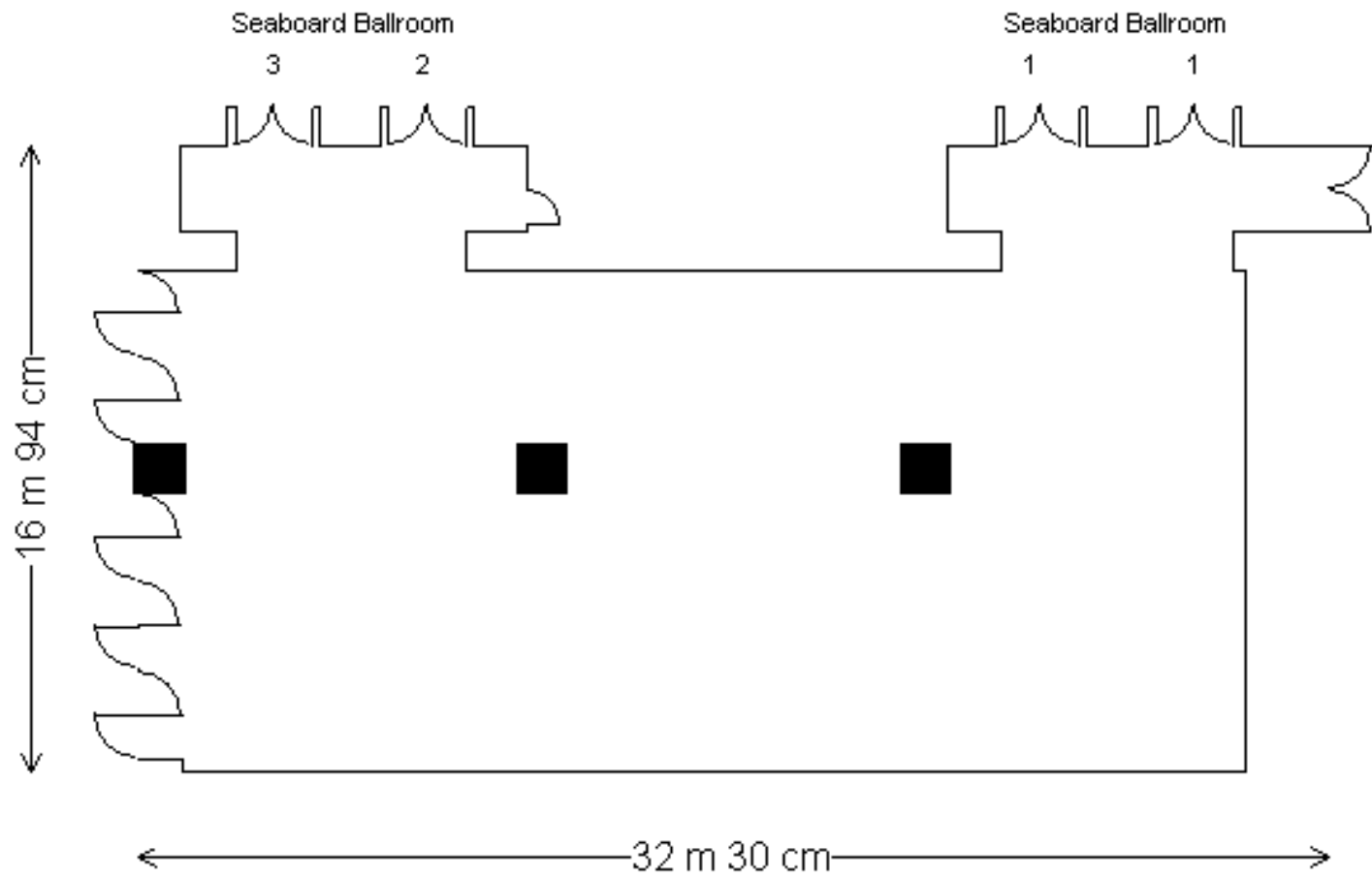

**PRE FUNCTION OF SEABOARD BALLROOM**

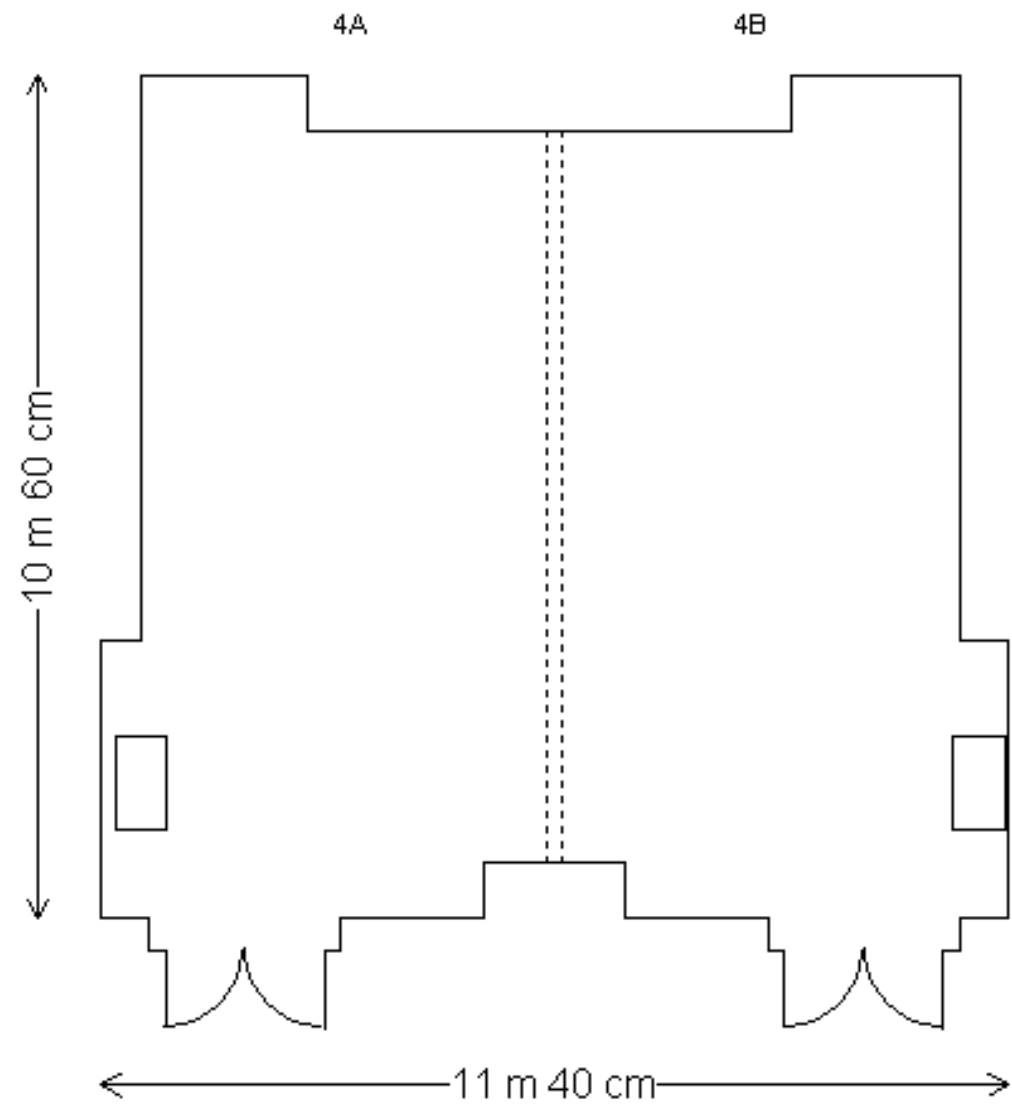

**SEABOARD ROOM 4**



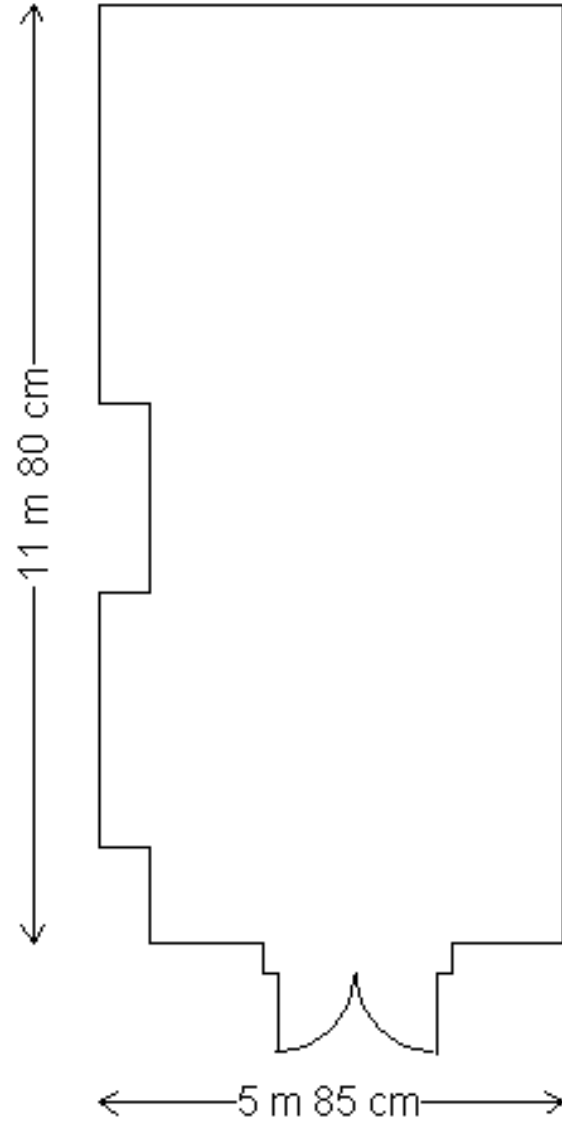

**SEABOARD ROOM 5**

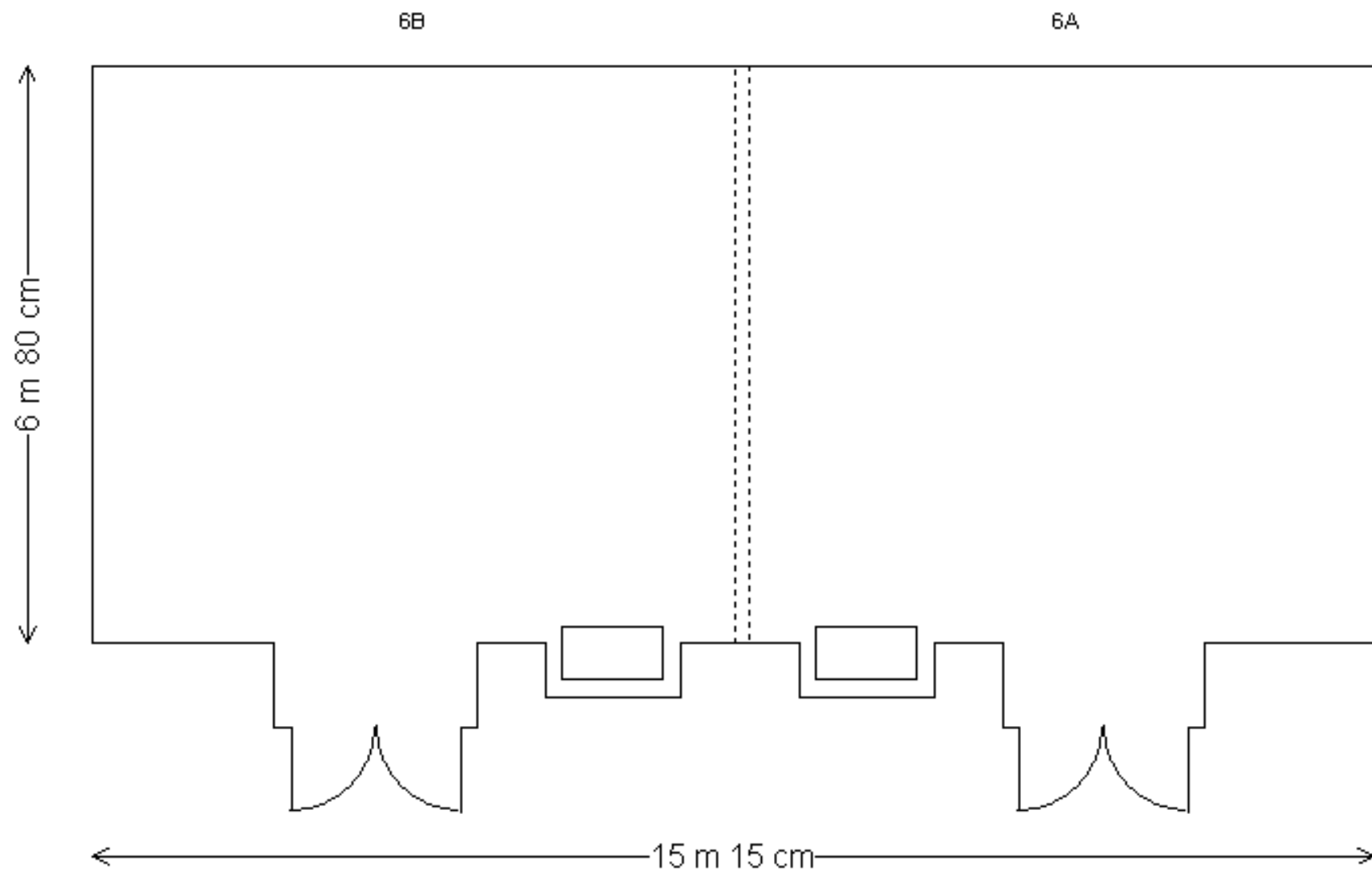

**SEABOARD ROOM 6**

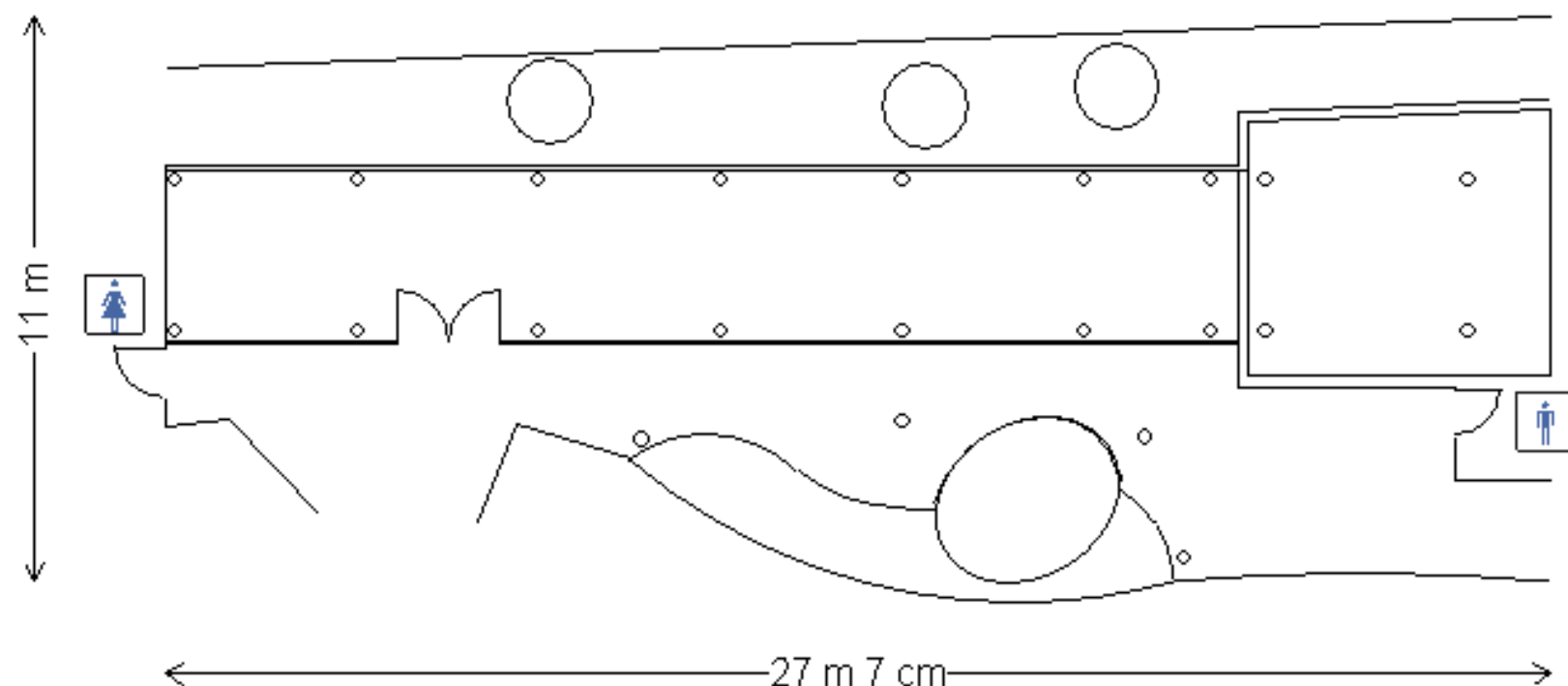

**SUNDECK**

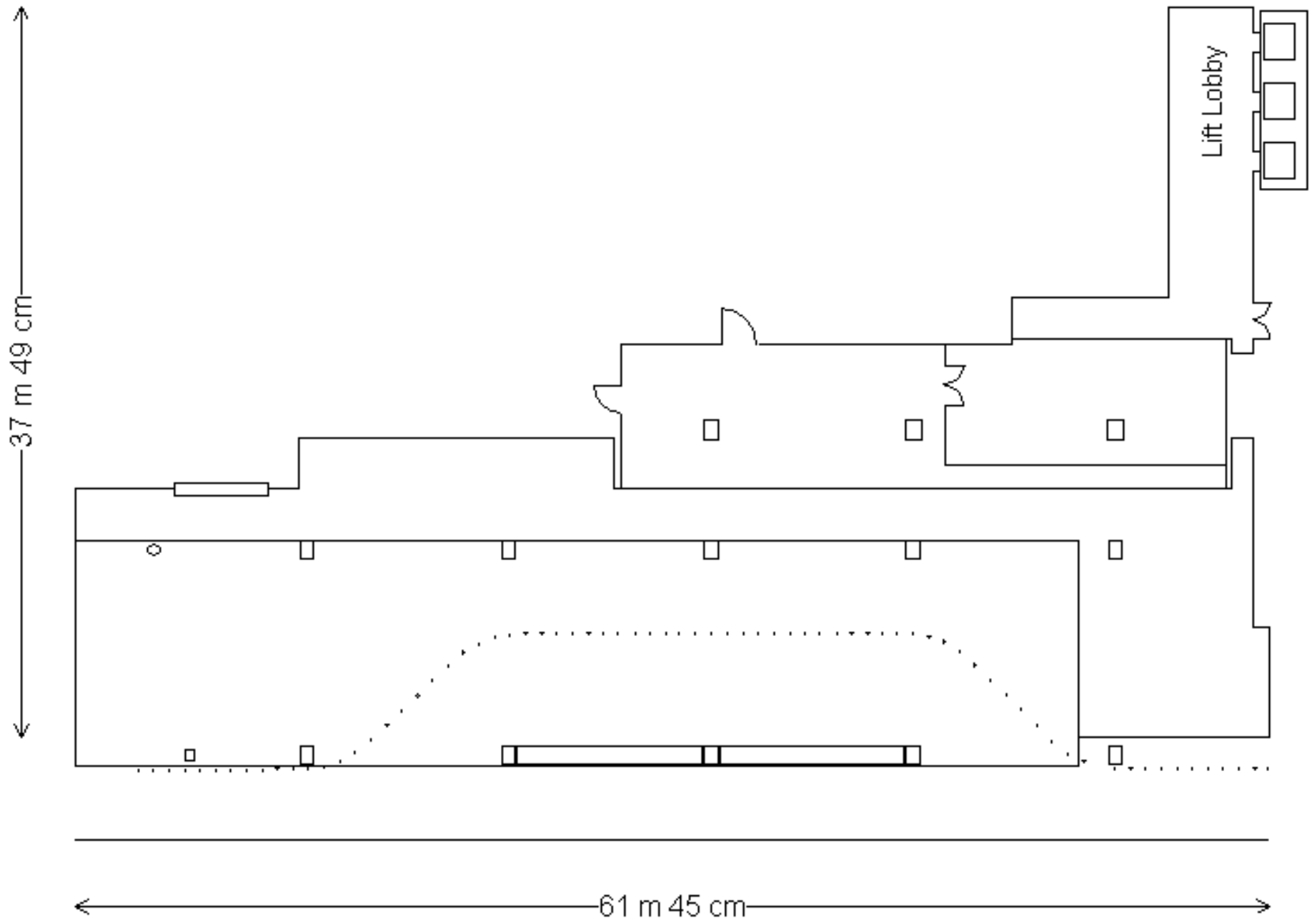

**WELCOME LOBBY**